

# Guide for Laser Tube Installation (M Series)

## Box-opening and Appearance Inspection

Place the laser tube carton in a spacious place full of light, cut the tape gently, take out the laser tube and its foam support, and check the appearance.

### 1-1 High Voltage Side

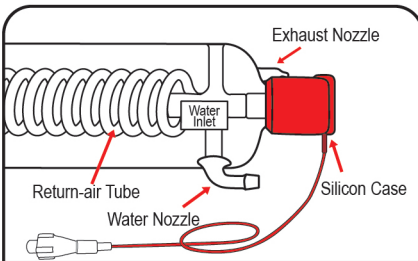

1-1. Place the laser tube carton in a spacious place full of light, cut the tape gently, take out the laser tube and its foam support, and check the appearance.

### 1-2 Low Voltage Side

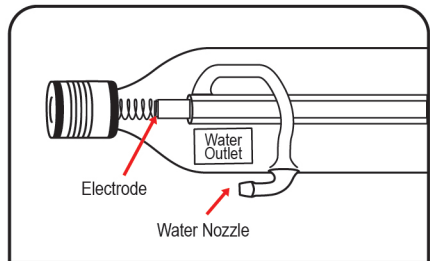

1-2. Check the laser tube for any of the following: any fall of the front and rear nozzles, silicon case, any fall off or damage to the electrode plate, any damage of front and rear water nozzles, exhaust nozzle, and any damage to the return-air tube, cooling water tube, or discharge tube inside the laser tube.

Check the laser tube for any of the following: any fall of the front and rear nozzles, silicon case, any fall off or damage to the electrode plate, any damage of front and rear water nozzles, exhaust nozzle, and any damage to the return-air tube, cooling water tube, or discharge tube inside the laser tube.

After the appearance inspection, operator A holds the tube with two hands and operator B removes the foam support on tube.

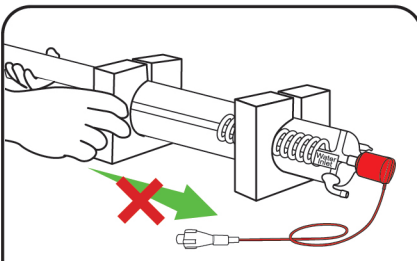

2. Attention: Do not push the foam to the end of the laser tube and remove it from both ends.

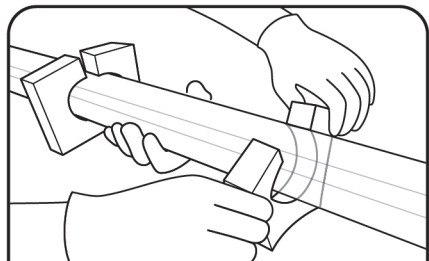

3. The correct action is to open the support with two hands, and then gently removes it.

## Preparing for installation

Place the laser tube gently on the machine bracket.

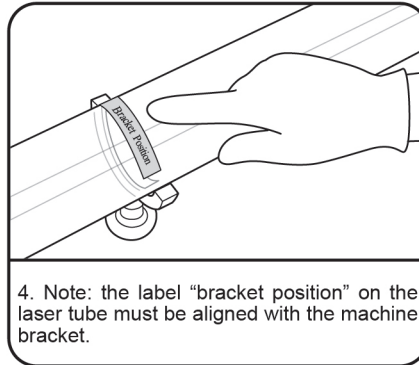

Avoid these parts touches the machine: welding wires, water nozzle, tube ends and electrode pins.

Check the high voltage side and laser output side, if they are correctly placed on.

## Connect the water chiller and laser tube

Use only silicon tubes with an inner diameter of 6-7mm and tube thickness of 1.5-2.0mm, connect the water chiller outlet to the water nozzle on the high voltage side (marked "water inlet"). The silicon tube should be set to the nozzle root so that the silicon tube will not drop neither no water leaking. Do not use detergent or lubricant.

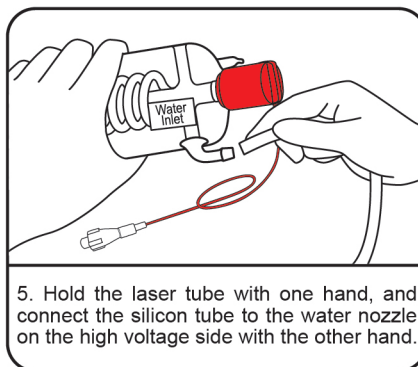

Use only silicon tubes with an inner diameter of 6-7mm and tube thickness of 1.5-2.0mm, connect the water chiller inlet to the water nozzle on the laser output side (marked "water outlet"). The silicon tube should be set to the nozzle root so that the silicon tube will not drop neither no water leaking.

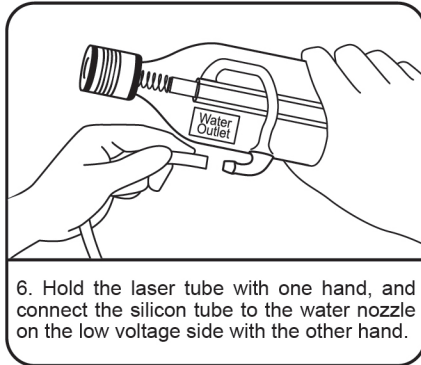

**Connect the machine with laser tube**

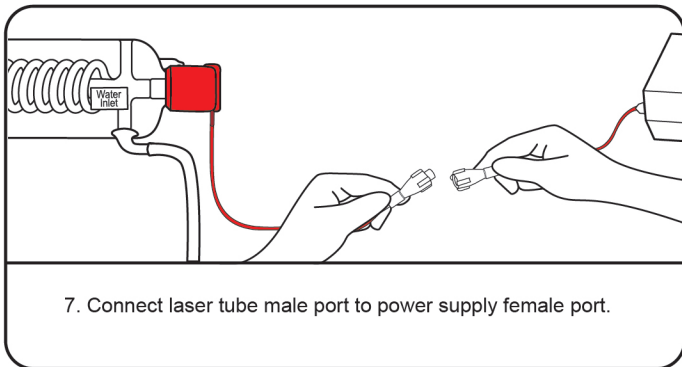

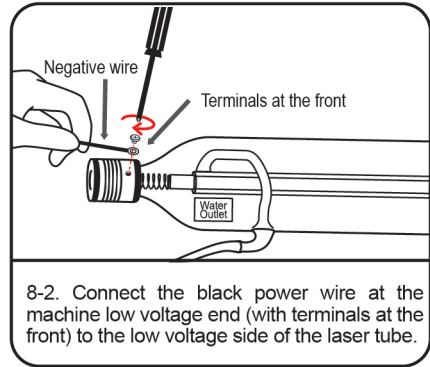
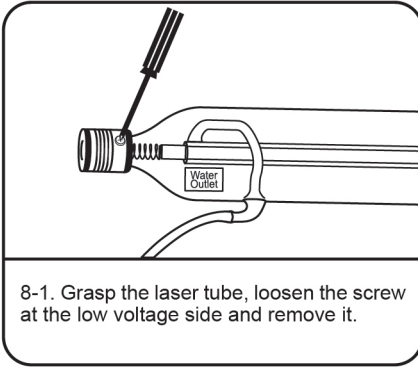

Grasp the laser tube, loosen the screw at the low voltage side and remove it. Connect the black power wire at the machine low voltage end (with terminals at the front) to the low voltage side of the laser tube.

### Connect the water cooling system

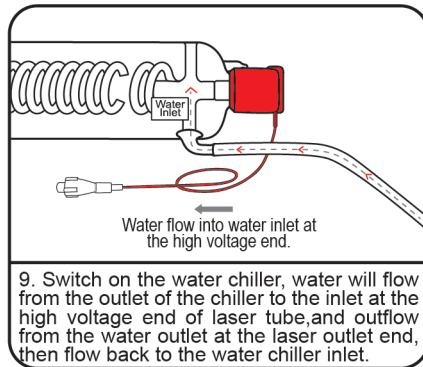

Note: Please check the water flow direction, water flow into water inlet at the higher voltage end, and flow out from the water outlet at laser outlet end. If the direction is not correct, cooling water will not fulfill the water tube. Then the cooling efficiency is low, the laser power is low, and the explosion risk increases.

(The laser tube has three layers. The inner layer is the discharge tube, the middle layer is the water pipe, and the outer layer is the gas storage pipe.)



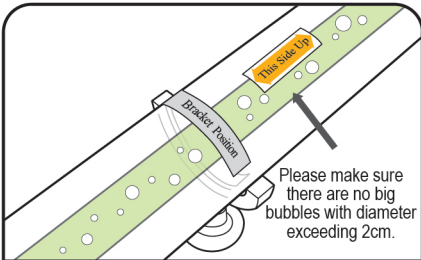

10. After water fills the water tube, check if there is big bubble.

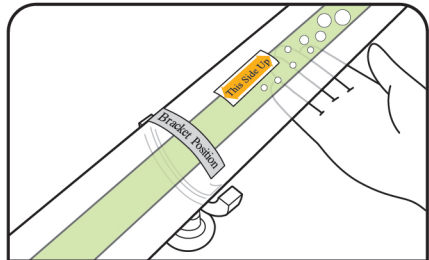

11. If there is bubble with diameter more than 2cm, user must lift the laser output side by approximately 3 to 5 cm, so that the bubbles flow out.

Please make sure there are no big bubbles with diameter exceeding 2cm, as they will reduce the cooling efficiency and increases the explosion risk. If the big bubbles cannot be removed by lifting the laser output end for 30 seconds, please check if the chiller has enough water or not, the chiller flow is enough or no. If the chiller flow is insufficient, please replace the chiller.

## Power on the laser machine

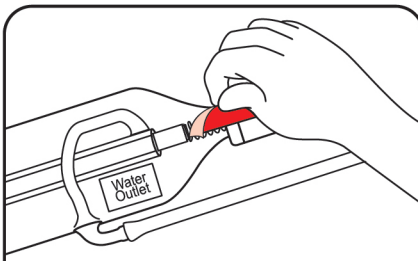

12. Peel off the red label "Please tear the label before use ", and attach it to the blank space.

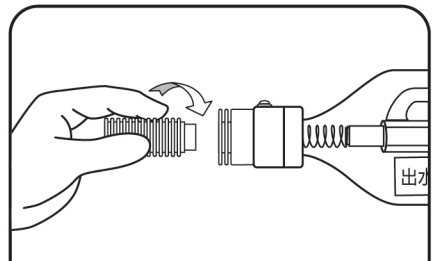

13. Rotate the dust mask clockwise and fix it on the heat dissipation cap on the laser output end.

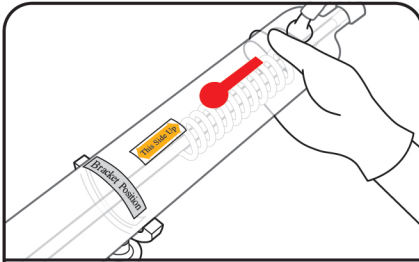

14. Turn the laser tube clockwise, and make sure the label " This Side Up " faces up.

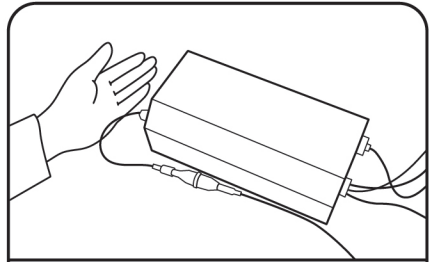

15. Turn on the power supply and check if the fan is running or not. If the fan is not running, please change the power supply.

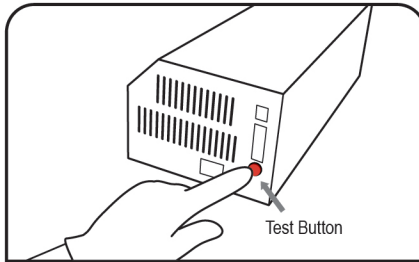

16. Press the test button on the power supply and check if there is abnormal sound from the laser power supply.

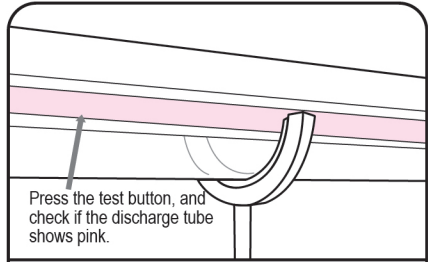

Press the test button, and check if the discharge tube shows pink.

17. Meanwhile, check the discharge tube in the laser tube. The discharge tube should show pink color when the laser tube is working normally.

If the laser discharge tube shows purple, white, or no color, please contact us for further instruction.

Fasten the laser tube on the machine brackets, once this is complete, installation is finished.

The next step is to adjust the laser delivery system of the machine. After that, you can operate the machine normally.

# CO<sub>2</sub> Laser Tube Operating Instruction (M Series)

## 1. Installation Request

Please install in strict accordance with the Installation diagram of M series. The laser is equipped with a special power supply (see the table below for specific power supply model). The positive electrode zone is high voltage. The starting voltage is shown in the table below.

Results caused by wrong installation: firing, the inner tube was broken and leak water.

Model	Power Supply	The Starting Voltage
M1	P2	24kV
M2	P2	27kV
M4	P4	32kV
M6	P6	37kV
M8	P6	35kV

## 2. Working Request

Water Cooling: cooling liquid must be pure water, flow is 3-5 Liter per minute, standard water temperature: 10°C-40°C.

Working Environment: 2-40°C, humidity: 10-60%.

Model	Detected Current	Allowed Maximum Working Current	Daily Working Current	Working Life (under Daily Working Current)
M1	25mA	25mA	24mA	10000Hours
M2	28mA	28mA	27mA	10000Hours
M4	30mA	30mA	28mA	10000Hours
M6	30mA	30mA	28mA	10000Hours
M8	30mA	30mA	28mA	10000Hours

Table description (take M1 as an example) : Detected current 25mA, allowed maximum working current 25mA, daily working current must be less than 24mA. If working current is less than 24mA, the laser tube working life can be 10000hours. The above mentioned current is the current showed in the Ammeter which is series connected to cathode.

If the user does not operate as this request: the cathode will change color when used for a long period of ultra-current, and the laser tube service life will be greatly shortened.

To protect the electrode from dust, please wrap the high voltage cap by plastic wrap.

### 3. Performance

Cutting.

Engraving.

### 4. Notification

The output mirror surface cannot be cleaned by anything even if cotton ball. Otherwise the power will be reduced a lot.

Cleaning Instruction is as follows: 1) do not turn on the laser if the mirror is dirty, 2) blow the mirror surface by oblique front balloon, 3) spray pure alcohol to the mirror surface by injector, 4) do not turn on laser till the alcohol is volatilized, 5) If none of the above cleaning methods is effective, a professional staff can use the cotton ball which is completely soaked with 75% alcohol, wipe the output windows from the center towards the edge in the same direction. Please do not clean it back and forth which may scratch the windows, and reduces output power. 6) It is best to protect the output mirror from dust. Please note, do not clean it by acetone. 7) When test the light spot on acrylic, please keep the acrylic 300mm away from output mirror.

### 5. Safety

Since the laser tube is making invisible light, goggles is requested during operation. The anode has high voltage. Please note the safety signs.

### 6. Storage and Transportation

Before storage or transportation, please drain out the cooling liquid, cover the output side by plastic bag. The storage environment should be 2-40°C, humidity is 10-60%, and pack it in factory way. Packing notification: please do stick the laser tube and sponge strongly by tape, which will avoid the laser tube longitudinally sliding. At the end of the output mirror, the packing sponge should protrude 70 mm; At the end of the full mirror, the packing sponge should protrude 50mm.

### 7. Operation goes against this manual has no quality promise.

### INSTALLATION DIAGRAM OF CO<sub>2</sub> LASER TUBE MODEL M1

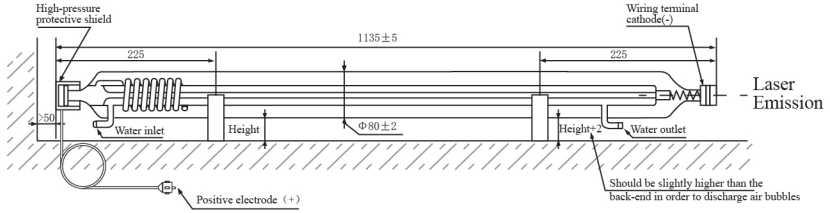

### INSTALLATION DIAGRAM OF CO<sub>2</sub> LASER TUBE MODEL M2

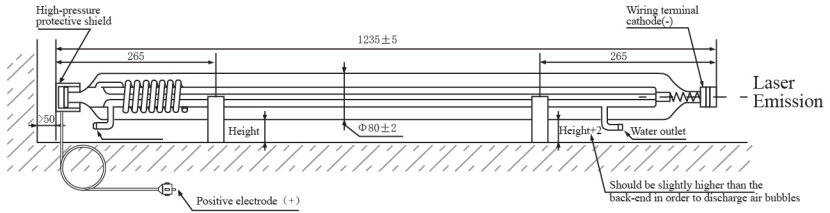

### INSTALLATION DIAGRAM OF CO<sub>2</sub> LASER TUBE MODEL M4

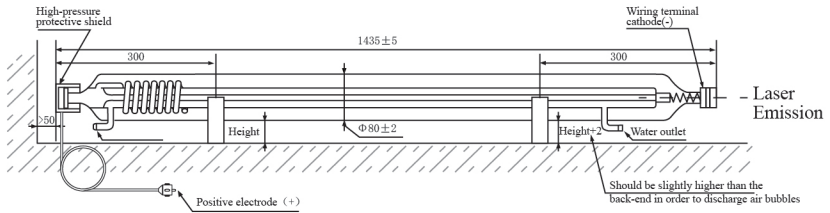

### INSTALLATION DIAGRAM OF CO<sub>2</sub> LASER TUBE MODEL M6

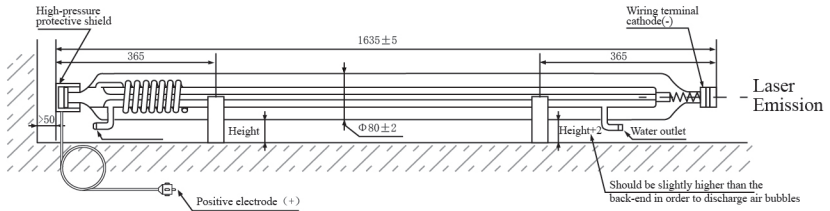

### INSTALLATION DIAGRAM OF CO<sub>2</sub> LASER TUBE MODEL M8

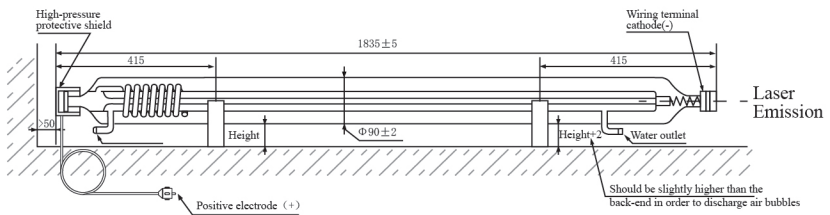

# Cautions

## 1. Water Inlet and Outlet of Laser Tube

Attention: The water inlet and outlet shall follow the principle of low into higher drainage. Please refer to the following diagram.

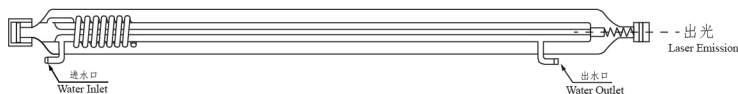

- 1) In order to fully circulate the cooling water of the laser tube, it is necessary to ensure that the water flow enters from the low point and drain away from the high point under the pressure of the water so as to achieve the cooling of the entire laser tube.
- 2) If the flow direction is opposite, it is possible that the cooling water can not fill the whole pipe, resulting in poor cooling, power reduction and the phenomenon of tube burst.
- 3) If there is air bubbles in the laser tube, before the dimming, lift the water outlet side, until the bubble is completely discharged, and then fixed laser tube. Please be careful not to allow residual bubbles in the laser tube. On one hand it will influence the luminous effect, on the other hand it will lose the laser power. If the laser tube is poor cooling caused by bubble for long time, it may burst.

## 2. Installation Instructions

- 1) According to the marked fixed position on the tube, fix the laser tube on the machine and keep it be fixed on the horizontal plane.
- 2) Connect respectively the positive and negative line of laser power supply to the positive and negative line of laser tube. Pay attention to avoiding incorrectly connected line and make sure good insulation. (The rear end with the spiral glass tube is positive end)
- 3) Connect the chiller with the laser, the chiller outlet is connected to the laser inlet, and the chiller inlet is connected to the laser outlet.
- 4) Open the chiller to ensure that the cooling water is filled with the laser water cooling tube and the bubbles are completely drained.
- 5) When the laser tube is started, it normally adjusts 50-60% of the power to work.

6) Within the recommended maximum current, using laser can still be output rating power. Exceeding the recommended maximum current, using the laser will shorten the life of the laser tube.

### 3. If the following fault occurs, please check the below items.

1) Weak Power/Low Power, please check:

☆The windows of laser tube is clean or not. If there is scratch, dirt or dust. The bracket is placed correctly or not.

☆Output current and voltage, cooling water temperature, cleanliness and water flow.

☆Lens & mirror surface is clean or not, hot or not. Laser path is shifted or not.

2) High voltage side firing.

☆High voltage is close to metal or not; if there is something around high voltage cap or not.

☆Indoor humidity is too high to conduct electricity; Avoid condensation in summer.

☆Power supply and laser tube high voltage wire and connections is damaged or not.

3) Laser tube broken, water cooling cap dropped.

☆Water temperature should be between 15°C-25°C, and should avoid cooling water freezing In cold area. After laser is power off, please discharge the water if the temperature is under ZERO.

☆When laser is working, the water cooling must be working on same time to protect laser tube(please test if the laser is on/off along with water on/off).

☆Cooling water pipe is folded or pressed or not.

☆There is bubble inside laser tube or not.

☆Water pressure and water flow is working or not; water flows in low level and flows out on high level.

4) Laser tube windows dirt.

☆During laser tube working, the environment and material cutting smoke may pollute the windows easily. We recommend user check the windows at least every two weeks, and clean it if any pollution.

The output mirror surface cannot be cleaned by anything even if cotton ball. Otherwise the power will be reduced a lot. Cleaning Instruction is as follows:

☆Do not turn on the laser if the mirror is dirty.

☆Blow the mirror surface by oblique front balloon.

☆Spray pure alcohol to the mirror surface by injector.

☆Do not turn on laser till the alcohol is volatilized.

☆If none of the above cleaning methods is effective, a professional staff can use the cotton ball which is completely soaked with 75% alcohol, wipe the output windows from the center towards the edge in the same direction. Please do not clean it back and forth which may scratch the windows, and reduces output power.

☆It is best to protect the output mirror from dust. Please note, do not clean it by acetone.

☆When test the light spot on acrylic, please keep the acrylic 300mm away from output mirror.

☆Warning: if user cannot check every two weeks, and clean the pollution in time, the laser tube runs with pollution in long time, not only the laser power will down, the windows will break also. We will not give warranty for any problem because of this reason.

## 4. Warning

If the laser tube is powered on without circling cooling water, it will break immediately. In this condition, the laser tube will have no warranty.

Before install and test the laser tube, please wear the protection glasses first.

If the laser needs to be returned to the manufacturer for repair, please make sure to use the complete original packaging.

Before package and transport, please make sure to contact Beijing HM Laser Co., Ltd. and get agreement in advance.

Before packaging, the cooling water in the laser tube must be vented completely.